



Trusted RF Solutions™

HILNA GPS Low Noise Amplifier

1200 - 1600 MHz
32 dB Gain

P/N: HILNA-GPS

(includes NW-LN-ACC-CB02CA interface cable)



NuWaves' HILNA GPS™ is a broadband low noise amplifier designed to achieve high gain while maintaining low noise and a high third order intercept point specifically for L1 (1575.43 MHz) and L2 (1227.6 MHz) GPS signals.

This high-performance module delivers 32 dB of gain across the frequency range of 1200 MHz to 1600 MHz with an OIP3 of +30 dBm and less than 1 dB of noise figure. The HILNA GPS is also usable up to 2000 MHz with 28 dB of gain (typical).

The HILNA GPS's robust power supply also operates over a very broad range easily allowing the unit to be integrated into systems without regard to power supply precision.

Features

- Broadband Operation
- Small Form Factor
- Low Noise and Extremely High Gain
- High Intercept Point
- Rugged Chassis
- Over-Voltage Protection
- Reverse-Voltage Protection
- Wide Input Voltage Range
- Internal Regulator/Active Bias Devices for Stability

Benefits

- Low Level Signal Amplification
- Improved Link Margin
- Ruggedized Chassis for Harsh Environments

Applications

- Wideband RF Front Ends
- High Performance Receivers
- Broadband High Gain Block
- Low Noise Transmit Driver
- RF Preamplifier
- RF Repeater
- Base Station LNA
- University Research and Instruction
- Multi-Signal Environment Amplifier

HILNA GPS Low Noise Amplifier

Specifications

Absolute Maximums

Parameter	Rating	Unit
Max Device Voltage	20	V
Max Device Current	150	mA
Max RF Input Power, $Z_L = 50 \Omega$	15	dBm
Max Operating Temperature	70	°C
Max Storage Temperature	85	°C

Export Classification
EAR99

Electrical Specifications @ 12 VDC, 25 °C, $Z_S=Z_L=50 \Omega$

Parameter	Symbol	Min	Typ	Max	Unit	Condition
Operating Frequency	BW	1200		1600	MHz	
RF Gain	G	30	33	35	dB	From 1200 MHz to 1600 MHz
			28		dB	Up to 2000 MHz
Reverse Isolation		45	53	56	dB	
VSWR	VSWR		1.5:1			Input
			2.0:1			Output
Noise Figure	NF	0.7	0.8	1.6	dB	
Third Order Intercept Point	OIP3	28	30	32	dBm	
Output Power @ 1dB Compression	P1dB	16	18	19	dBm	
Operating Voltage	VDC	5	12	20	V	
Operating Current	I_{DD}	130	140	150	mA	@ 12VDC (typ)

Mechanical Specifications

Parameter	Value	Unit	Limits
Dimensions	3.15 x 2.50 x 1.18	in	Max
Weight	5.0	oz	Max
RF Connectors, Input/Output	SMA Female		
DC Power Connector	2 mm Circular		

Environmental Specifications

Parameter	Symbol	Min	Typ	Max	Unit
Operating Temperature	T_C	-30		+70	°C
Storage Temperature	T_{STG}	-40		+85	°C
Relative Humidity (non-condensing)	RH			95	%
Altitude MIL-STD-810F - Method 500.4	ALT			30,000	ft
Vibration / Shock Profile (Random profile in x,y, z axis, as per Figure for 15 minute duration in each axis)					

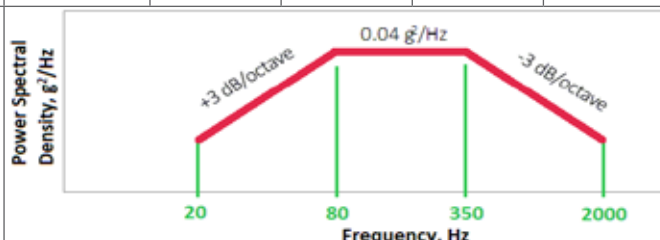

HILNA GPS Low Noise Amplifier

Performance Plots

Gain (S21)

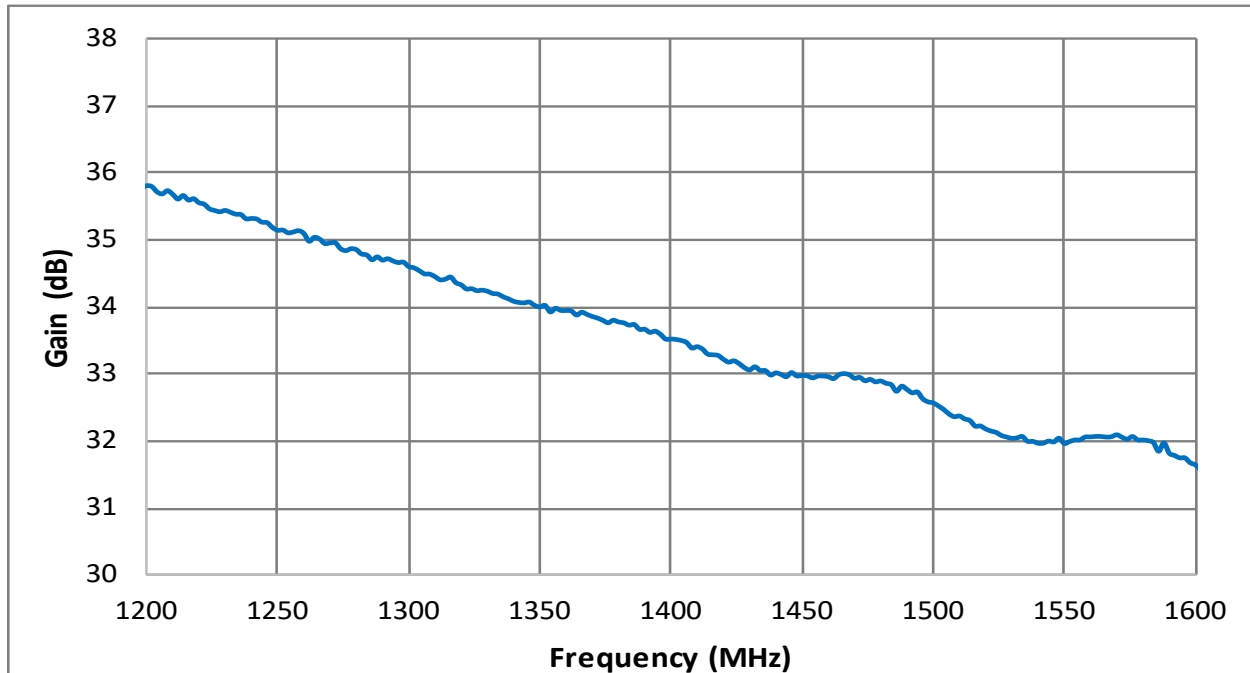

Noise Figure

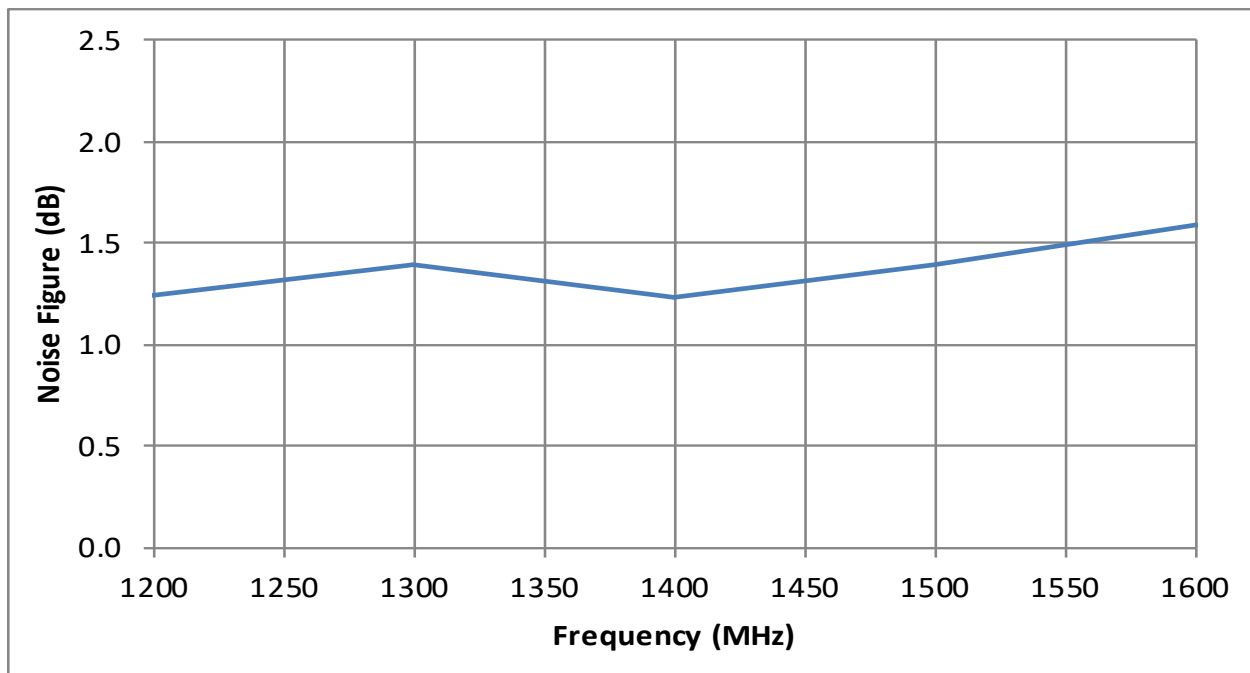

HILNA GPS Low Noise Amplifier

Performance Plots (cont.)

Output Power at 1 dB Compression Point

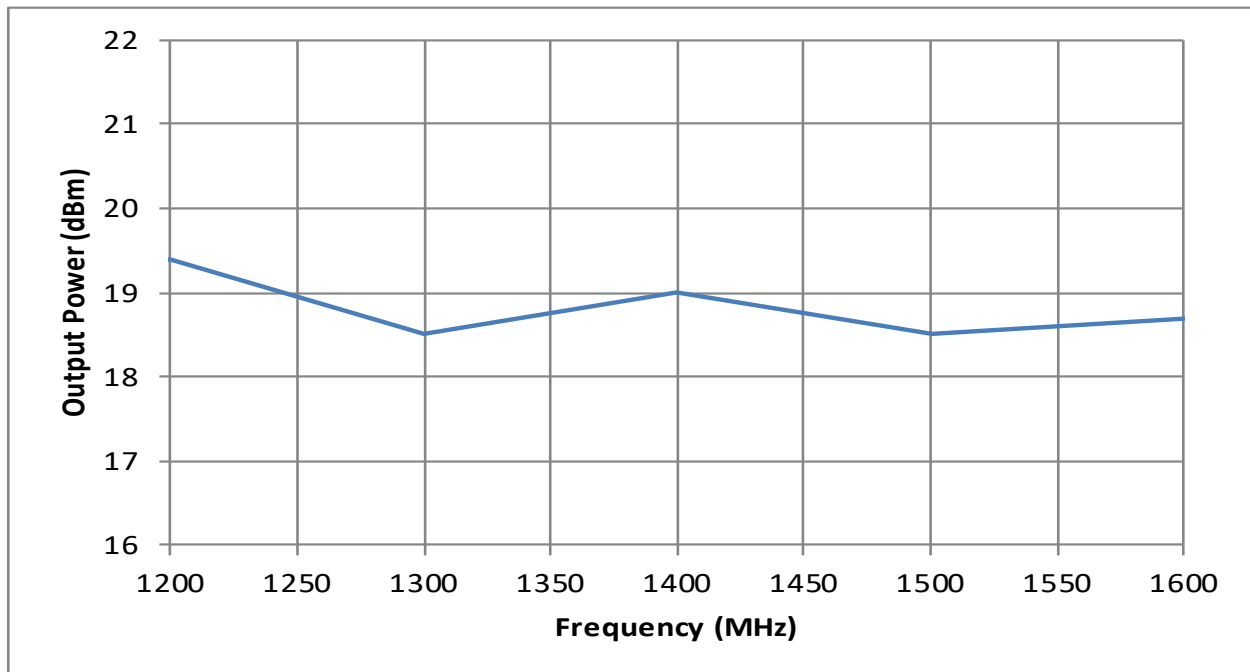

Power Compression

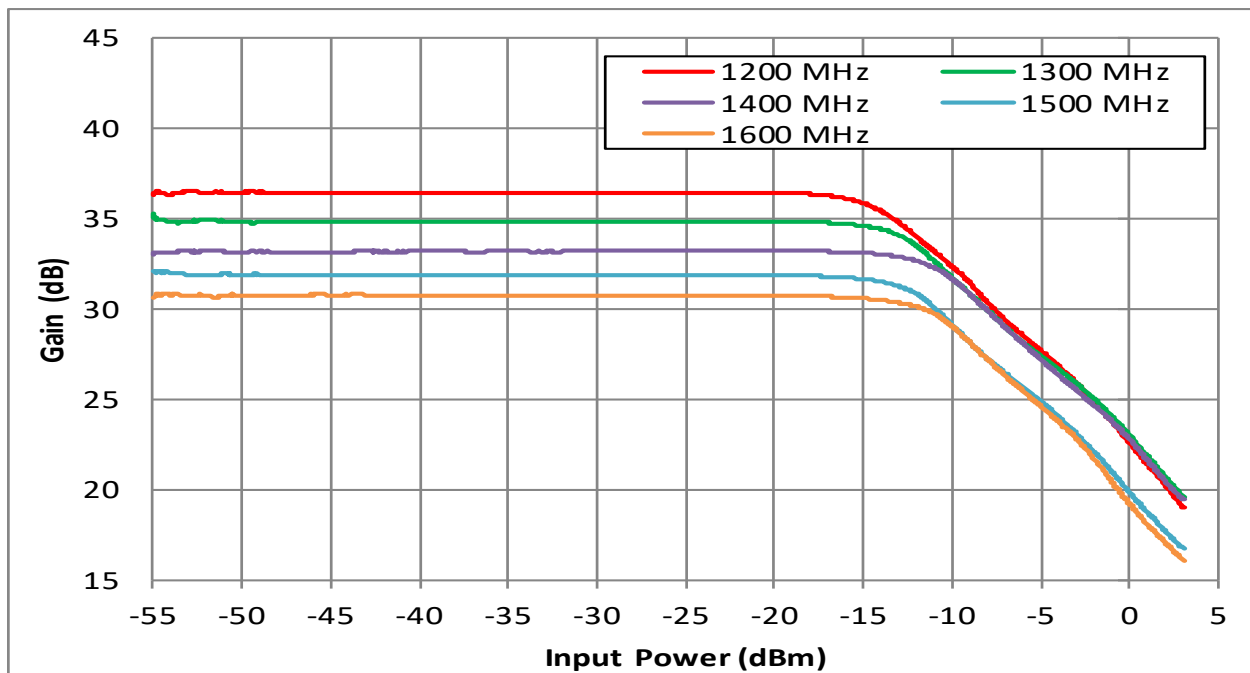

HILNA GPS Low Noise Amplifier

Performance Plots (cont.)

OIP3 vs Frequency

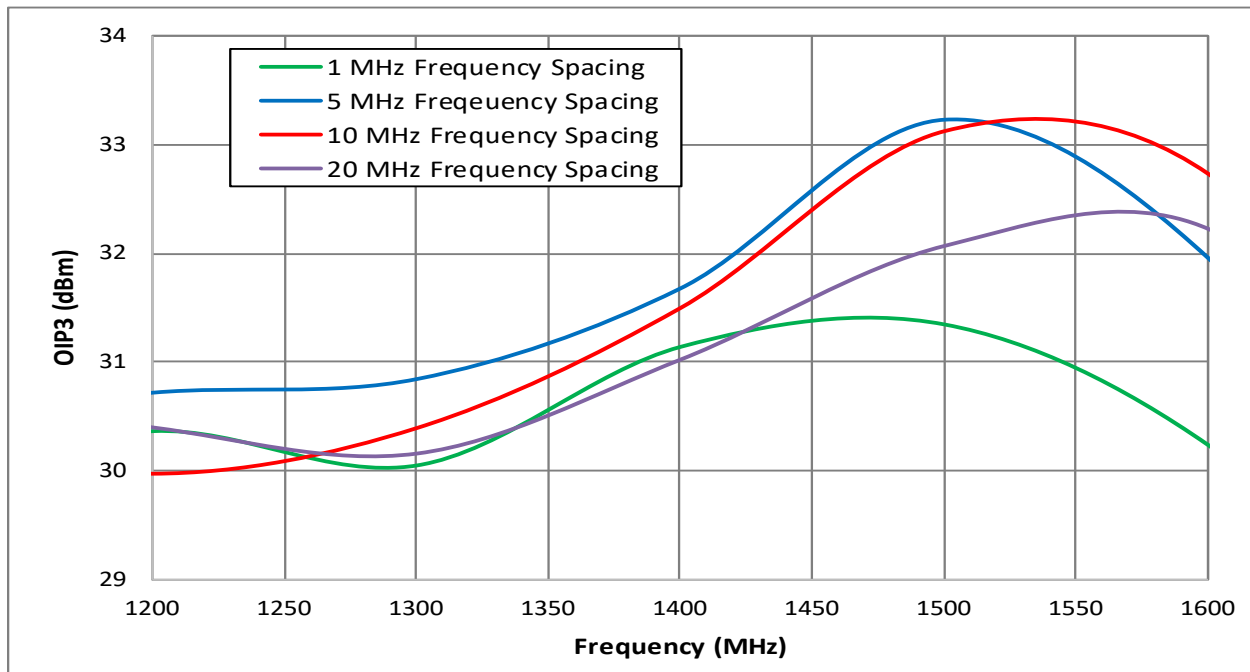

Reverse Isolation

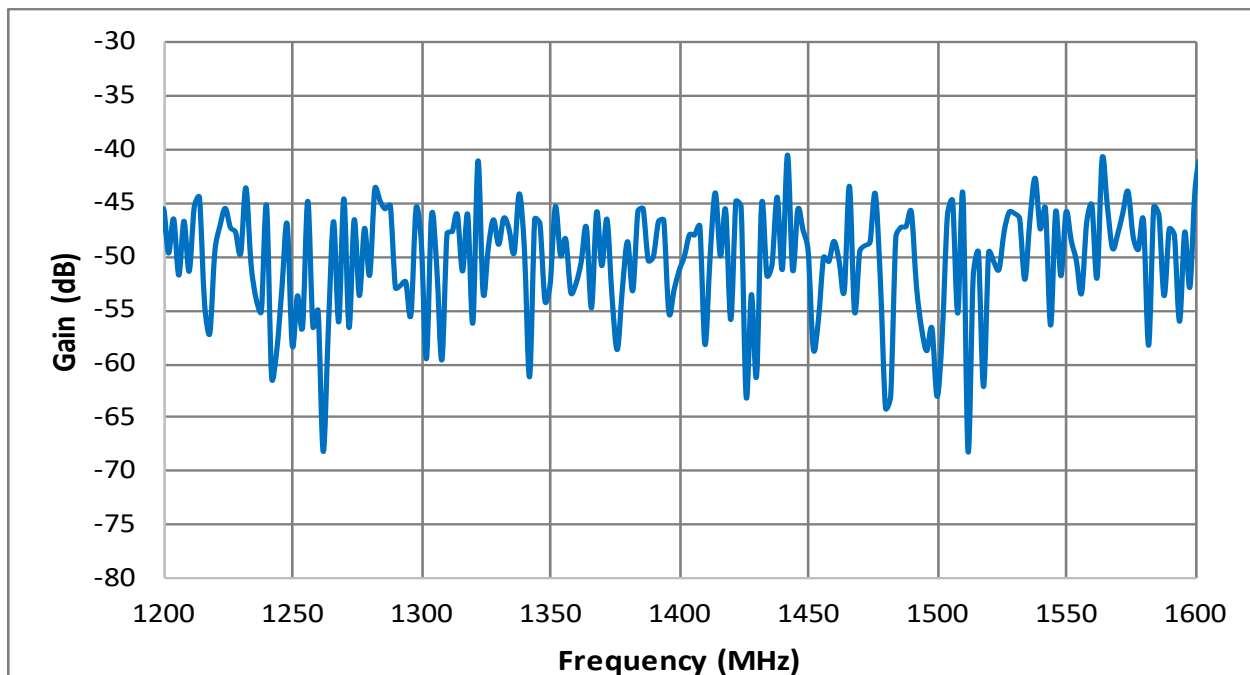

HILNA GPS Low Noise Amplifier

Performance Plots (cont.)

Input and Output VSWR

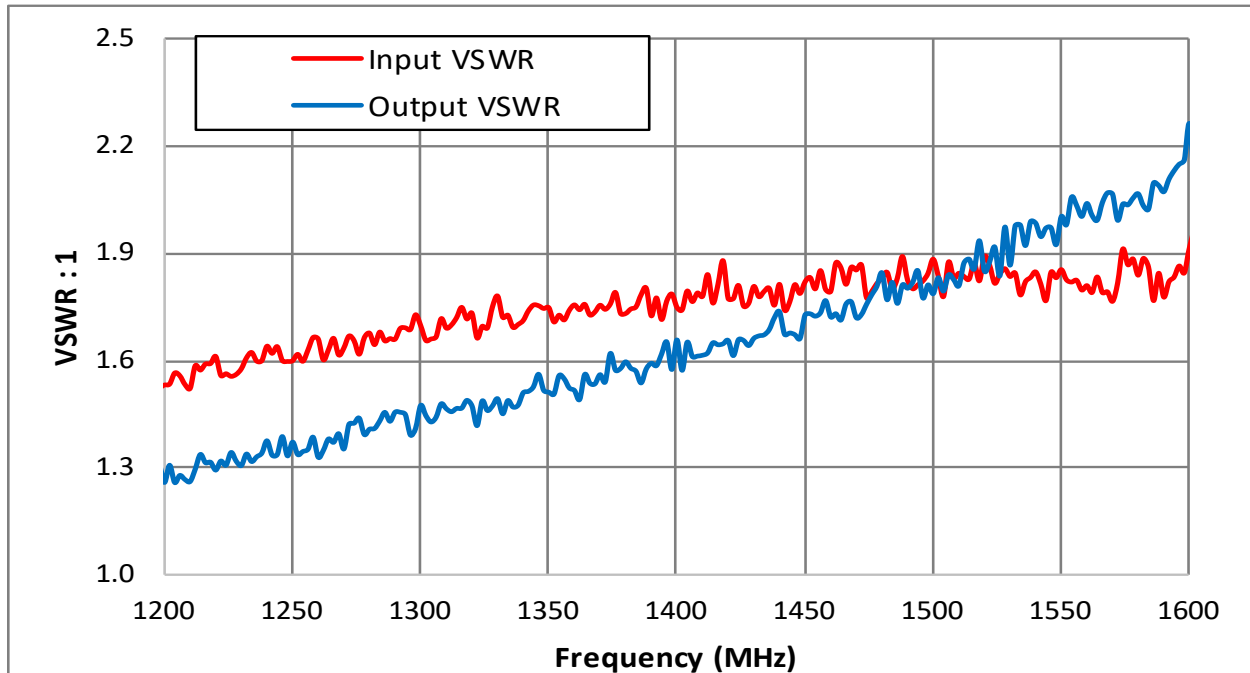

Gain vs Temperature

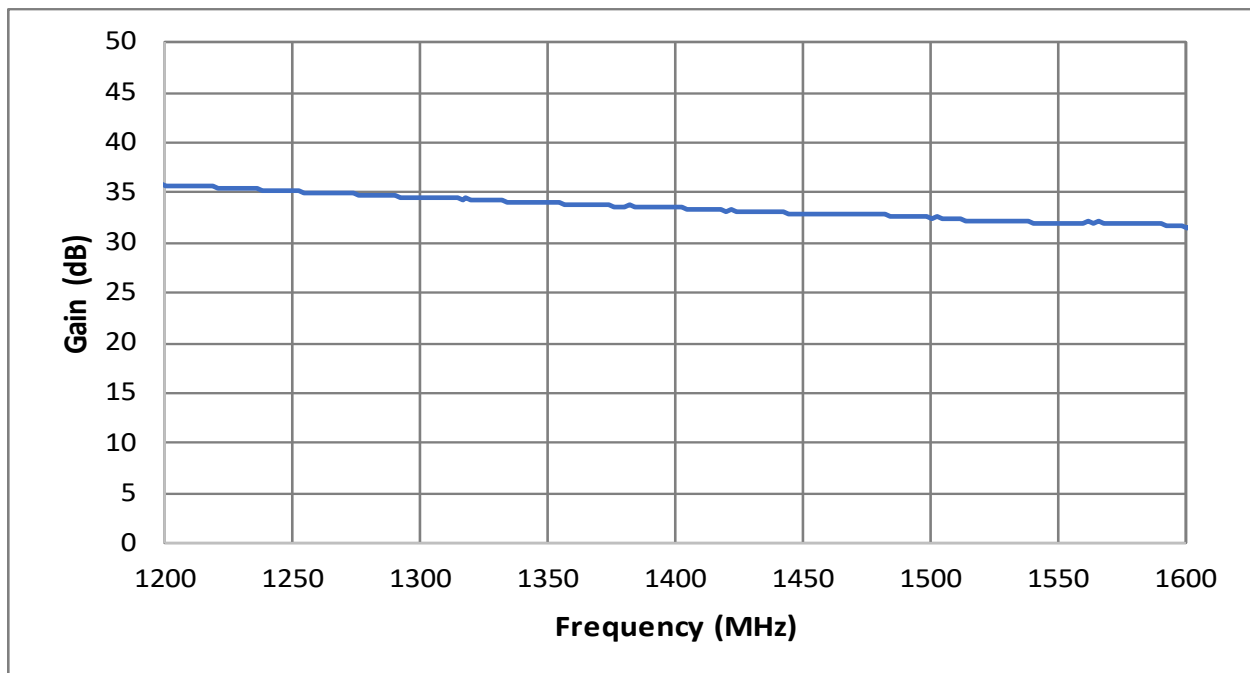

HILNA GPS Low Noise Amplifier

Mechanical Outline

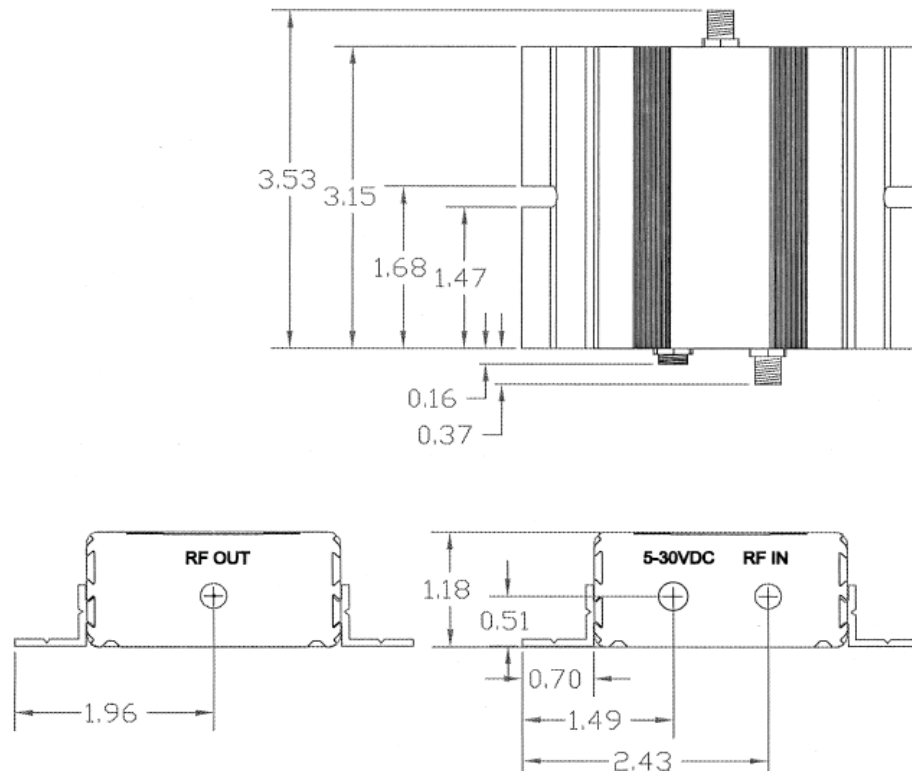

Accessory Part Numbers

Part Number	Description
NW-LN-ACC-CB02CA	Standard Interface Cable Assembly - Flying Leads (included w/ module)
NW-LN-ACC-CT02CA	Upgraded Interface Cable Assembly - Banana Plug Termination

Contact NuWaves



NuWaves Engineering
132 Edison Drive
Middletown, OH 45044

www.nuwaves.com
product.sales@nuwaves.com
513.360.0800

NuWaves
engineering
Trusted RF Solutions™